



GEM•2®

Flushometer Maintenance Guide



Gem Flushometer

The Gem Piston Flushometer has been offered by the Sloan Valve Company since 1928. The Gem has been used throughout the World and has a reputation for it's World Class Quality and Affordability.

Gem • 2

In 1985, Sloan redesigned the Gem to incorporate features that ensure optimum valve performance and water conservation. The new Gem•2 included the non-adjustable and non-hold open handle features that Sloan first introduced in the Royal Flushometer.

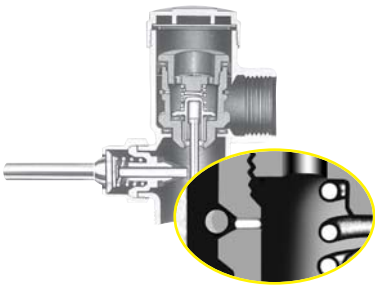

The Gem•2 also featured the patented Filtered O-ring Bypass. First introduced by Sloan in 1981, the Filtered O-ring Bypass protects the metering bypass in the piston from water bourn dirt and debris. Compared to screen filters, which can clog and are difficult to clean, the Filtered O-ring Bypass ensures continued, uninterrupted

valve performance, even in dirty water conditions.

Most current Gem parts can be used with older Gem models. This Maintenance Guide also identifies replacement parts and repair kits for the pre-1985 adjustable Gem models.

If you have any questions regarding Gem flushometers, please contact Sloan Installation Engineering:

- 1-888-SLOAN-14 (1-888-756-2614)
- Techsupport.com@sloanvalve.com

Gem Pistons

The piston in the Gem flushometer accurately controls the discharge volume of the flush. Sloan offers a wide range of pistons to meet the flushing requirements of both older and new design water closets and urinals.

Sloan uses a number of features to visually differentiate the Pistons. This includes the color and shape of the piston body, the number of grooves on the relief valve stem and, beginning in 2004, the color of the Piston cover.

The chart inside this Maintenance Guide can be used to identify these features.

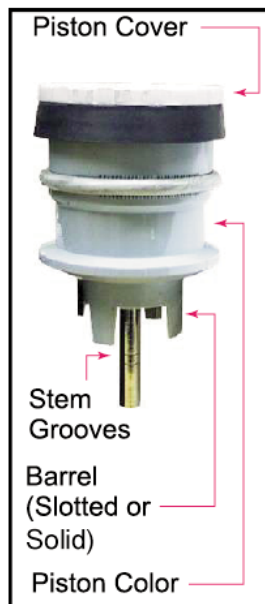

LIMITED WARRANTY

Sloan Valve Company warrants its Flushometer Products to be made of first class materials, free from defects of material or workmanship under normal use and to perform the service for which they are intended in a thoroughly reliable and efficient manner when properly installed and serviced for a period of 3 years (1 year for special finishes) from date of purchase. During this period, Sloan Valve Company will, at its option, repair or replace any part or parts which prove to be thus defective if returned to Sloan Valve Company, at customer's cost, and this shall be the sole remedy available under this warranty. No claims will be allowed for labor, transportation or other incidental costs. This warranty extends only to those persons or organizations who purchase Sloan Valve Company's products directly from Sloan Valve Company for purpose of resale.

THERE ARE NO WARRANTIES WHICH EXTEND BEYOND THE DESCRIPTION ON THE FACE HEREOF. IN NO EVENT IS SLOAN VALVE COMPANY RESPONSIBLE FOR ANY CONSEQUENTIAL DAMAGES OF ANY MEASURE WHATSOEVER.



SLOAN VALVE COMPANY • 10500 SEYMOUR AVE. • FRANKLIN PARK, IL. 60131
Phone: 1-800-9-VALVE-9 or 1-847-671-4300 • Fax: 1-800-447-8329 or 1-847-671-4380
www.sloanvalve.com

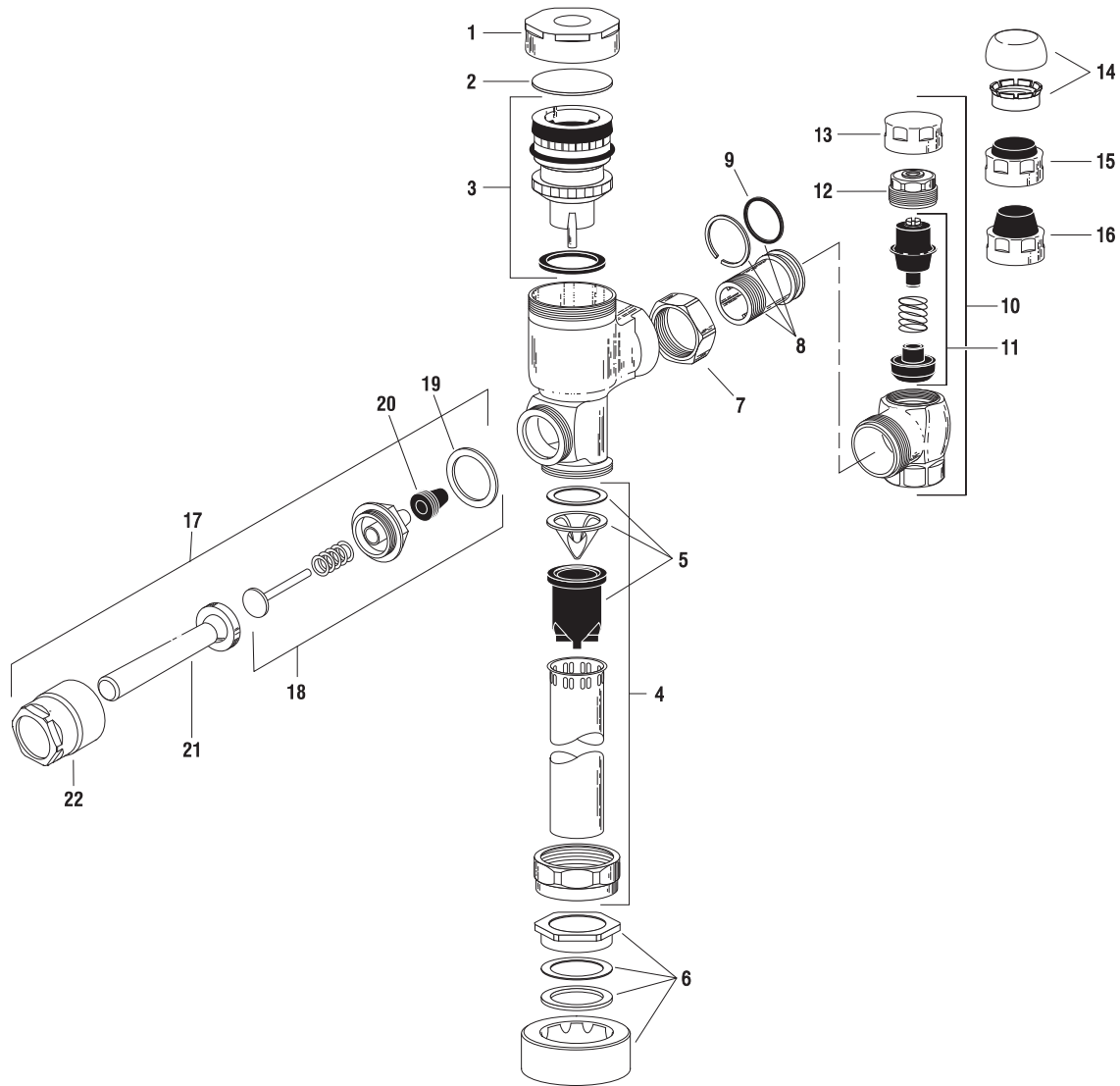

PARTS LIST

Item #	Code #	Part #	Description
1.	0307142	G-105	CP Cover
2.	0307139	G-106	Slip Disc
3.	0307193	G-1007-A	Piston Kit — 3.5 gpf/13.2 Lpf Water Closet
	0307195	G-1016-A	Piston Kit — 1.6 gpf/6.0 Lpf Water Closet
	0307192	G-1009-A	Piston Kit — 1.5 gpf/5.7 Lpf Urinal
	0307185	G-1017-A	Piston Kit — 1.0 gpf/3.8 Lpf Urinal
	3307133	G-1018-A	Piston Kit — 0.5 gpf/1.9 Lpf Urinal
	3307134	G-1019-A	Piston Kit — 2.4 gpf/9.0 Lpf Water Closet
PISTON KITS FOR OLD STYLE ADJUSTABLE GEM FLUSHOMETERS			
	0307043	G-1003-A	Piston Kit — Water Closet
	0307044	G-1002-A	Piston Kit — Urinal
ALL PISTON KITS INCLUDE G-21 MAIN SEAT (item H on page 3)			
4.	5323005	V-500-AA	3/4" x 9" Vacuum Breaker — 6 per pkg.
	5323006	V-500-AA	1-1/4" x 9" Vacuum Breaker — 6 per pkg.
	5323007	V-500-AA	1-1/2" x 9" Vacuum Breaker — 6 per pkg.
5.	3323192	V-551-A	Vacuum Breaker Repair Kit
6.	3332000	CR-1008-A	3/4" Spud Coupling
	3332001	CR-1009-A	1-1/4" Spud Coupling
	3332002	CR-1010-A	1-1/2" Spud Coupling
7.	0308676	H-550	Stop Coupling
8.	0308801	H-551-A	Adjustable Tailpiece 2-1/16"
9.	5308696	H-553	O-ring — 24 per pkg.







Item #	Code #	Part #	Description
10.	0388000	H-700-A	1" Screwdriver Bak-Chek® Stop CP — complete
	0388001	H-700-A	3/4" Screwdriver Bak-Chek® Stop CP — complete
11.	3308853	H-541-A	Control Stop Repair Kit †
	3308856	H-543-A	Control Stop Repair Kit ‡
12.	0308612	H-622	CP Bonnet †
	0308843	H-577	CP Bonnet ‡
13.	3308840	H-573-A	Locking Vandal Resistant Control Stop Cap CP †
	0308848	H-582	Control Stop Cap CP ‡
14.	3308791	H-1010-A	Vandal Resistant Control Stop Cap Assembly †
	3308790	H-1009-A	Vandal Resistant Control Stop Cap Assembly ‡
15.	3308866	H-574	Control Stop Cap w/Bumper †
16.	3308867	H-576	Control Stop Cap w/Extended Bumper †
HANDLE REPAIR KIT			
17.	0307100	G-143	Handle Assembly
18.	5307074	G-50-A	Handle Repair Kit - 6 per pkg.
19.	5307065	G-35	Handle Gasket - 48 per pkg.
20.	5302297	B-39	Handle Seal - 12 per pkg.
21.	0307024	G-145	Handle Grip
22.	0307020	G-144	Handle Socket

† For use w/H-700-A 1" & 3/4" and H-600-A 1" Screwdriver Bak-Chek® Control Stops.

‡ For use w/H-600-A 3/4" Screwdriver Bak-Chek® Control Stops.







GEM•2® Flushometer Pistons

GEM•2 Water Closet Piston

 G-77-1 0307187	 G-77-3 0307183	 G-77-2 0307182
 G-1007-A 0307193 3.5 gpf/13.2 Lpf	 G-1016-A 0307195 1.6 gpf/6.0 Lpf	 G-1019-A 3307134 2.4 gpf/9.0 Lpf
Piston Color - Gray	Piston Color - Black	Piston Color - Gray
Barrel - 4 Slots	Barrel - 5 Slots	Barrel - 4 Slots
Stem Grooves - 2	Stem Grooves - 2 ‡	Stem Grooves - 0
Cover Color - White	Cover Color - Green	Cover Color - Blue

‡ Prior to Feb. 2006 - 1 Groove.

GEM•2 Urinal Piston

 G-77-4 0307105	 G-77-5 0307184	 G-77-6 0307194
 G-1009-A 0307192 1.5 gpf/5.7 Lpf	 G-1017-A 0307185 1.0 gpf/4.0 Lpf	 G-1018-A 3307133 0.5 gpf/1.9 Lpf
Piston Color - Black	Piston Color - Black	Piston Color - Black
Barrel - Solid	Barrel - Solid	Barrel - Solid
Stem Grooves - 2	Stem Grooves - 1	Stem Grooves - 3
Cover Color - Black	Cover Color - Yellow	Cover Color - Red

PISTON KIT

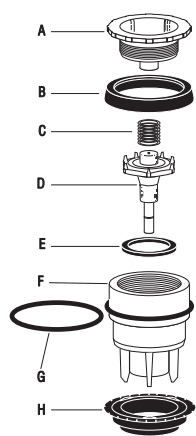

PISTON COMPONENTS			
LETTER	CODE NO.	PART NO.	DESCRIPTION
A			Piston Cover
B	5307106	G-78	Molded Cup — 12 per pkg.
C	0307130	G-102	Spring
D			Relief Valve
E	0307116	G-95	Relief Valve Seat
F			Piston Body
G	0307210	G-85	Filter O-ring
H	5307052	G-21	Main Seat — 6 per pkg.
REPAIR KIT			
	3307128	G-1011	Repair Kit includes items: 2, 5, 6 (page 2), B, C, E, G & H

HANDLE ASSEMBLY FOR OLD STYLE GEM FLUSHOMETERS (Pre-May-2003)

Item #	Code #	Part #	Description
1.	N/A	G-36-A	Handle Assembly - 6 per pkg.
2.	5307074	G-50-A	Handle Repair Kit - 6 per pkg.
3.	5307065	G-35	Handle Gasket - 48 per pkg.
4.	5302297	B-39	Handle Seal - 12 per pkg.
5.	N/A	G-36	Handle Grip
6.	N/A	G-28	Handle Socket

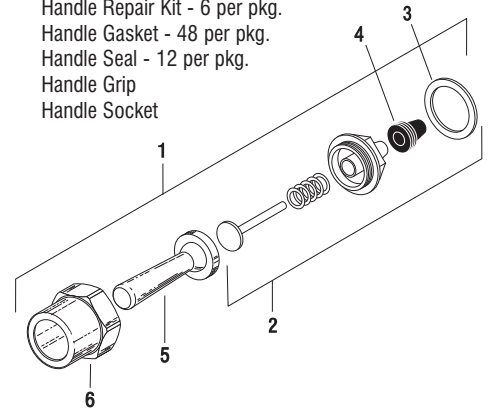

REPAIR PARTS FOR OLD STYLE GEM FLUSHOMETERS (Pre-1985)

Adjustable Cover

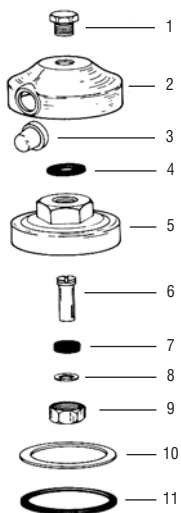

Repair Parts

Item #	Code #	Part #	Description
1.	N/A	G-24	CP Cover Screw
2.	N/A	G-23	CP Cover
	N/A	G-26	CP Cover for Bumper
3.	5307061	G-27	CP Cover for Bumper (12 per package)
4.	0307058	G-25	Cover Screw Gasket (12 per package)
5.	0307058	G-4	RB Inside Cover
6.	0307025	G-6	RB Regular Screw
7.	N/A	S-26	Packing
8.	N/A	S-24	Packing Disc
9.	N/A	G-10	RB Packing Nut
10.	N/A	G-65	Gasket
11.	N/A	G-5	Gasket

Old Style Piston

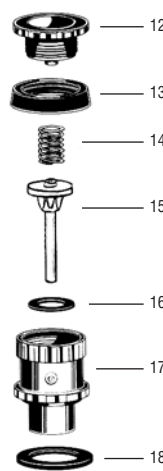

Repair Parts

Item #	Code #	Part #	Description
12.	0307105	G-77	Piston Cover
13.	0307106	G-78	Molded Cup
14.	0307113	G-84	Spring
15.	0307110	G-81-A	Relief Valve
16.	0307112	G-83	Relief Valve Seat
17.	0307101	G-75	Closet Piston Body
	N/A	G-76	Urinal Piston Body
18.	0307052	G-21	Main Seat

REPLACE OLD STYLE PISTONS WITH:

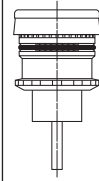
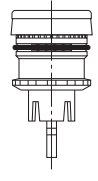
URINAL	WATER CLOSET
G-1002-A	G-1003-A
For Old Style Adjustable Gem Valves	
	
Piston Color-Black	Piston Color-Black
Barrel-Solid	Barrel-Slotted
Grooves-0	Grooves-0
G-75-AU	G-75-AC

SPUD COUPLING FOR OLD STYLE GEM FLUSHOMETERS (Pre-May, 2003)

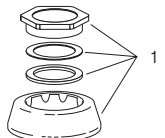

Item #	Code #	Part #	Description
1.	0306125	F-5-A	3/4" Spud Coupling
	0306140	F-5-A	1-1/4" Spud Coupling
	0306146	F-5-A	1-1/2" Spud Coupling